



# Smart Hospitality Display

## HAU8000 Series (EU)

43 50 55 65 75

### HIGHLIGHTS

- Enhance content with 4K UHD Crystal Display for perfect picture quality
- Slim design that complements any interior while saving space
- Centralized management of hotel displays worldwide
- Optimize promotions and offers using personalized guest insights
- Customize content and empower system integrators to build web applications

### Key features



#### Lifelike color, in its purest state with fine crystal

Elevate your hotel's entertainment experiences with Dynamic Crystal Color. With a billion shades of color, every subtlety can be seen from the comfort of the hotel room.

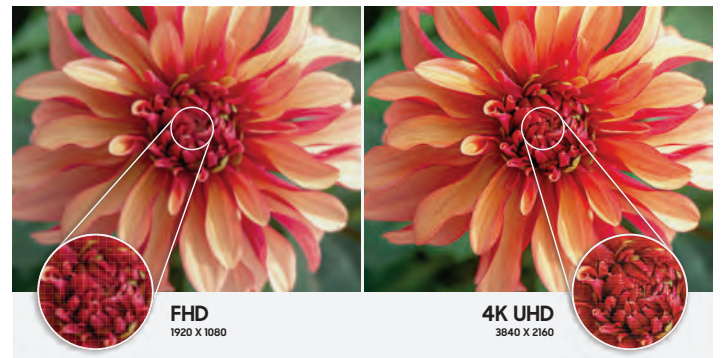

#### Feel the reality of 4K UHD Resolution

Offer guests the vivid picture quality of home entertainment systems, using upscaling technology to display content in UHD resolution (3,840 X2,160), four times the pixels of standard FHD.



#### Sleek and slim, more than ever

Increase flexibility with ultra-slim design, enabling hotel operators to create optimized room layouts that increase guest comfort.



#### The richer sounds of synergy between TV and soundbar

By seamlessly synchronizing the Samsung TV and soundbar, this powerful combination delivers sound simultaneously from both devices without any complicated setup.

# HAU8000 Hospitality Solution

## LYNK Cloud



### Streamlined property management

With online access that supports multiple users, Samsung LYNK Cloud is ideal for global hospitality operations with centralized management, giving users control of their hotel displays worldwide.

\* LYNK Cloud does not support management of properties within China.

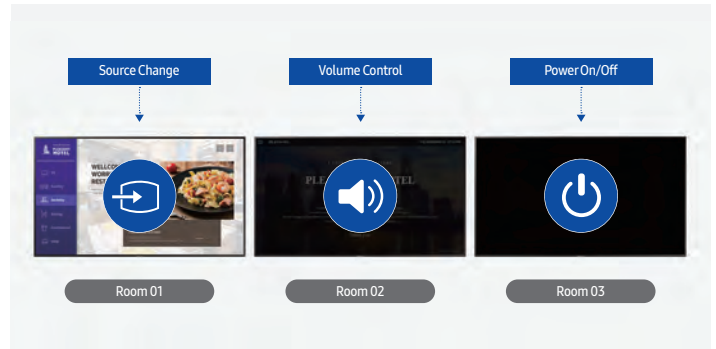

### Integrated device management

Quickly update in-room TVs from a centralized source with Samsung LYNK Cloud. Managers can modify channel maps and program guides and control basic functions, making it easier than ever to provide support and maintenance.

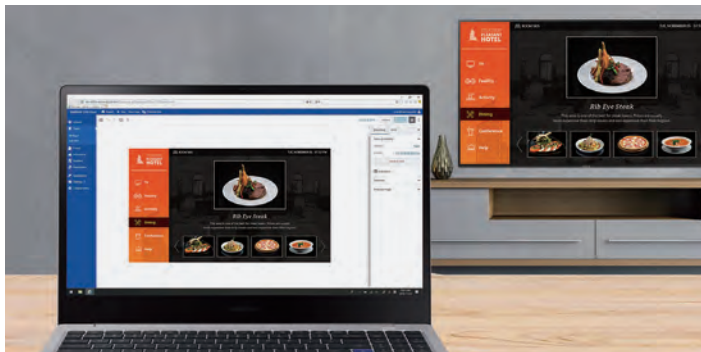

### Content creation and custom interactions

Curate your hotel's in-room experience with LYNK Cloud. Create and remotely deploy web-based content to each in-room TV for a tailored feel to your property. With interactive requests support, you can provide the easiest way for guests to make room service orders and book spa appointments.

\* Some features may not be compatible with hotel's current platforms.

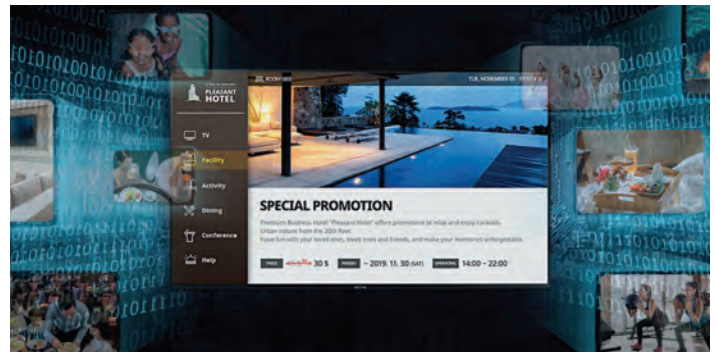

### Data-driven promotional planning

Samsung LYNK Cloud enables optimized promotional content delivery based on integrated guest data available through the hotel PMS, helping managers to uncover business insights.

## H.Browser

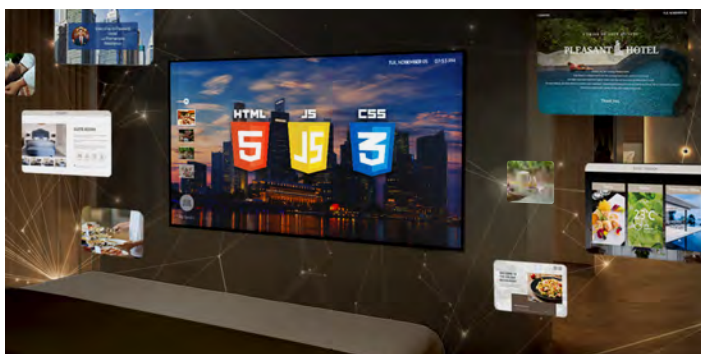

### Simple, compatible web app development

Create greater content development flexibility. H.Browser provides superior in-room entertainment and enables system integrators to develop smarter hospitality solutions. Apps stored in TIZEN OS are supported by Web Simulator and Remote Web Inspector tools to refine performance and security.

## Home App



### Easier, Faster control with Home App and Eden UI

Incorporate welcome messages, add logos/branding and provide other useful information such as phone extensions to various guest services. Display on the Eden user interface is a sleek, fast and simple solution.

\* Available apps may vary by region.

# Specifications

Model		43"	50"	55"	65"	75"
Display	Product	LED	LED	LED	LED	LED
	Resolution	3,840 x 2,160	3,840 x 2,160	3,840 x 2,160	3,840 x 2,160	3,840 x 2,160
Video	Picture Engine	Crystal Processor 4K	Crystal Processor 4K	Crystal Processor 4K	Crystal Processor 4K	Quantum Processor Lite
	Micro Dimming	UHD Dimming	UHD Dimming	UHD Dimming	UHD Dimming	UHD Dimming
	Auto Motion Plus	Yes	Yes	Yes	Yes	Yes
	LED Clear Motion	Clear Motion	Clear Motion	Clear Motion	Clear Motion	Clear Motion
	Film Mode	Yes	Yes	Yes	Yes	Yes
	PQI (Picture Quality Index)	2200	2200	2200	2200	2200
	HDR(High Dynamic Range)	HDR	HDR	HDR	HDR	HDR
	HDR10+	Support	Support	Support	Support	Support
	HLG (Hybrid Log Gamma)	Yes	Yes	Yes	Yes	Yes
	Contrast	Mega Contrast	Mega Contrast	Mega Contrast	Mega Contrast	Mega Contrast
Audio	Color	Dynamic Crystal Color	Dynamic Crystal Color	Dynamic Crystal Color	Dynamic Crystal Color	Dynamic Crystal Color
	Viewing Angle (H/V)	178/178	178/178	178/178	178/178	178/178
	Contrast Enhancer	Yes	Yes	Yes	Yes	Yes
	Dolby Digital Plus	Yes	Yes	Yes	Yes	Yes
	Sound Output (RMS)	20W	20W	20W	20W	20W
	Speaker Type	2CH	2CH	2CH	2CH	2CH
	Bluetooth Audio	Yes	Yes	Yes	Yes	Yes
	Smart TV	Smart	Smart	Smart	Smart	Smart
	TV Plus	Yes (GB, FR, DE, IT, ES, CH, AT)	Yes (GB, FR, DE, IT, ES, CH, AT)	Yes (GB, FR, DE, IT, ES, CH, AT)	Yes (GB, FR, DE, IT, ES, CH, AT)	Yes (GB, FR, DE, IT, ES, CH, AT)
	Web Browser	Yes	Yes	Yes	Yes	Yes
VESA	VESA Mount	200 x 200 mm	200 x 200 mm	200 x 200 mm	400 x 300 mm	400 x 400 mm
	VESA Screw Size	M8	M8	M8	M8	M8
	VESA Screw Depth	11-13	11-13	11-13	11-13	11-13
	Mobile to TV - Mirroring, DLNA	Yes	Yes	Yes	Yes	Yes
	WiFi Direct	Yes	Yes	Yes	Yes	Yes
General Feature	Sound Mirroring	Yes	Yes	Yes	Yes	Yes
	Accessibility	UK English, German, French, Spanish, Italian, Dutch, Polish, Danish, Swedish, Finnish, Norwegian, Portuguese, Russian(only when connecting to				
	Auto Channel Search	Yes	Yes	Yes	Yes	Yes
	Auto Power Off	Yes	Yes	Yes	Yes	Yes
	Caption (Subtitle)	Yes	Yes	Yes	Yes	Yes
	Connect Share™ (HDD)	Yes	Yes	Yes	Yes	Yes
	ConnectShare™ (USB 2.0)	Yes	Yes	Yes	Yes	Yes
	EPG	Yes	Yes	Yes	Yes	Yes
	OSD Language	27 European Languages + Russian(only when connecting to Network in EE, LV, LT)				
	BT HID Built-in	Yes	Yes	Yes	Yes	Yes
System	USB HID Support	Yes	Yes	Yes	Yes	Yes
	Teletext (TTX)	Yes	Yes	Yes	Yes	Yes
	Ambient Mode	Ambient Mode	Ambient Mode	Ambient Mode	Ambient Mode	Ambient Mode
	MBR Support	Yes	Yes	Yes	Yes	Yes
	IPv6 Support	Yes	Yes	Yes	Yes	Yes
System	Digital Broadcasting	DVB-T2CS2	DVB-T2CS2	DVB-T2CS2	DVB-T2CS2	DVB-T2CS2
	Analog Tuner	Yes	Yes	Yes	Yes	Yes
	CI (Common Interface)	CI(1.4) / CI(1.4 ECP)_IT only	CI(1.4) / CI(1.4 ECP)_IT only	CI(1.4) / CI(1.4 ECP)_IT only	CI(1.4) / CI(1.4 ECP)_IT only	CI(1.4) / CI(1.4 ECP)_IT only
Hospitality Feature	Data Broadcasting	HbbTV 2.0.2 (IT,GB,DE,CZ,SK,ES,PL,AT,FR,FI,EE,GR,SJ,HR,BE,NL,LU,LT,HU,CH,PT,DK,ME)/MHEG 5(IE)				
	H.Browser Compatibility	Yes	Yes	Yes	Yes	Yes
	Samsung LYNK™ Cloud	Yes	Yes	Yes	Yes	Yes
	Hospitality Home Menu 2.0	Yes	Yes	Yes	Yes	Yes
	Hospitality Plug&Play (Easy Set-up)	Yes	Yes	Yes	Yes	Yes
	Power On Mode	Yes	Yes	Yes	Yes	Yes
	Hotel Channel List	Yes	Yes	Yes	Yes	Yes
	Channel Menu Display	Yes	Yes	Yes	Yes	Yes
	Mixed Channel List (ATSC, DVB-T2/C/S2, Analog)	Yes	Yes	Yes	Yes	Yes
	My Channel	Yes	Yes	Yes	Yes	Yes
	Energy Saving Mode (BLU Control)	Yes	Yes	Yes	Yes	Yes
	RJ12/IR Pass Through	Yes	Yes	Yes	Yes	Yes
	Clock Back Up Supply	Yes	Yes	Yes	Yes	Yes
	USB Cloning	Yes	Yes	Yes	Yes	Yes
	Wake-up Timer (Alarm)	Yes	Yes	Yes	Yes	Yes
Input & Output	Samsung LYNK™ DRM	Yes	Yes	Yes	Yes	Yes
	Security Mode	Yes	Yes	Yes	Yes	Yes
	USB	2	2	2	2	2
	Ethernet (LAN)	Yes	Yes	Yes	Yes	Yes
	Digital Audio Out (Optical)	1	1	1	1	1
Input & Output	RF In (Terrestrial / Cable input / Satellite Input)	1/1(Common Use for Terrestrial)/1	1/1(Common Use for Terrestrial)/1	1/1(Common Use for Terrestrial)/1	1/1(Common Use for Terrestrial)/1	1/1(Common Use for Terrestrial)/1
	CI Slot	1	1	1	1	1
	HDMI A / Return Ch. Support	Yes	Yes	Yes	Yes	Yes
	WiFi	Yes (WiFi5)	Yes (WiFi5)	Yes (WiFi5)	Yes (WiFi5)	Yes (WiFi5)
	Anynet+ (HDMI-CEC)	Yes	Yes	Yes	Yes	Yes
	Variable Audio Out	Yes	Yes	Yes	Yes	Yes
	Variable Audio Out Volume Control	Yes	Yes	Yes	Yes	Yes
	RJ12	Yes	Yes	Yes	Yes	Yes
	Ethernet Bridge (LAN-Out)	Yes	Yes	Yes	Yes	Yes
	Front Color	BLACK	BLACK	BLACK	BLACK	BLACK
Design	Stand Type	FLAT LIFT	FLAT LIFT	FLAT LIFT	FLAT LIFT	FLAT LIFT
	Bezel Type	3 Bezel-less	3 Bezel-less	3 Bezel-less	3 Bezel-less	3 Bezel-less
	Energy Efficiency Class	G	G	G	G	G
Power	Eco Sensor	Yes	Yes	Yes	Yes	Yes
	Power Supply (V)	AC220-240V 50/60Hz	AC220-240V 50/60Hz	AC220-240V 50/60Hz	AC220-240V 50/60Hz	AC220-240V 50/60Hz
	Power Consumption (Max)	130 W	140 W	160 W	205 W	255 W
	Power Consumption (Stand-by)	0.50 W	0.50 W	0.50 W	0.50 W	0.50 W
Dimension	Power Consumption (Typical)	72.0 W	87.0 W	90.0 W	136 W	172 W
	Set Dimension without Stand (WxHxD)	965.5 x 559.9 x 25.7 mm	1118.3 x 644.6 x 25.7 mm	1232.1 x 708.8 x 25.7 mm	1450.9 x 831.9 x 25.7 mm	1676.7 x 960.3 x 26.6 mm
	Set Dimension with Stand (WxHxD)	965.5 x 600.1 x 195.1 mm	1118.3 x 684.6 x 226.3 mm	1232.1 x 748.8 x 226.3 mm	1450.9 x 874.3 x 279.4 mm	1676.7 x 1003.4 x 331.9 mm
Weight	Package Dimension (WxHxD)	1093 x 677 x 129 mm	1246 x 771 x 137 mm	1399 x 846 x 148 mm	1612 x 950 x 164 mm	1834 x 1110 x 190 mm
	Set Weight without Stand	8.4 kg	11.5 kg	15.5 kg	20.9 kg	31.4 kg
	Set Weight with Stand	8.7 kg	11.8 kg	15.8 kg	21.4 kg	32 kg
Accessory	Package Weight	11.9 kg	16 kg	22 kg	28.4 kg	42.3 kg
	Remote Controller Model	TM1640A	TM1640A	TM1640A	TM1640A	TM1640A
	Batteries (for Remote Control)	Yes	Yes	Yes	Yes	Yes
	Mini Wall Mount Supported	Yes	Yes	Yes	Yes	N/A
	VESA Wall Mount Supported	Yes	Yes	Yes	Yes	Yes
	Power Cable	Yes	Yes	Yes	Yes	Yes
	Quick Install Guide	Yes	Yes	Yes	Yes	Yes
Data Cable	Yes	Yes	Yes	Yes	Yes	
Optional Stand Support (Studio)	N/A	N/A	Yes	Yes	N/A	

# Technical drawings

## 43"

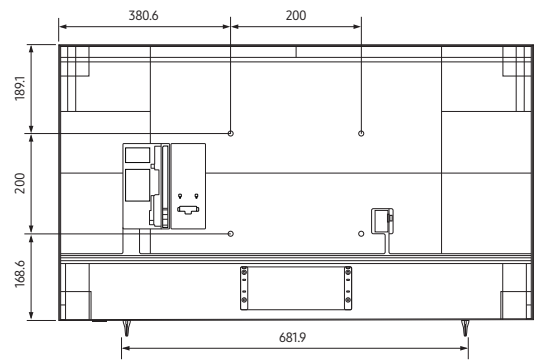
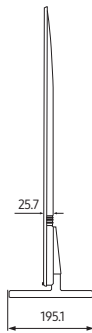
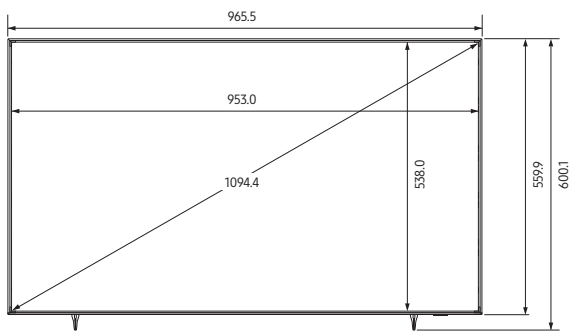

## 50"

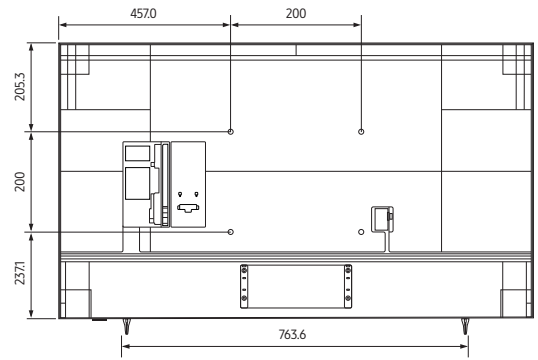
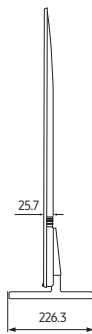
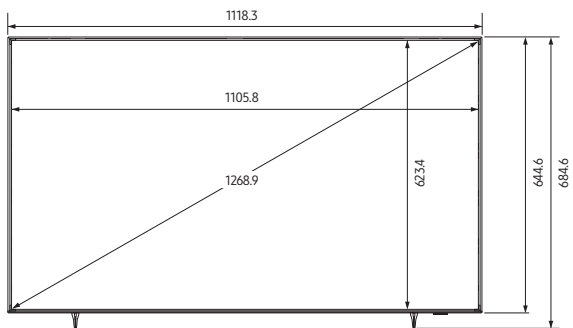

## 55"

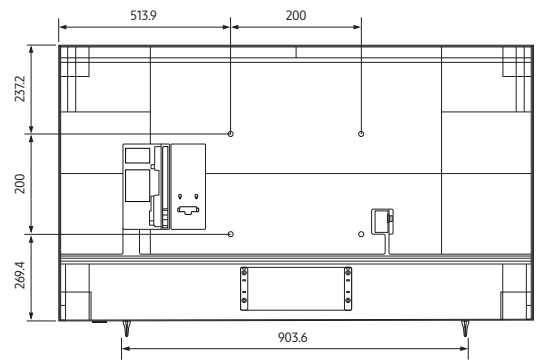
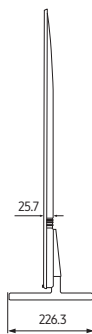
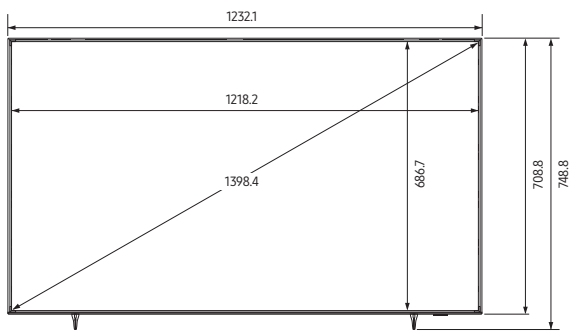

## 65"

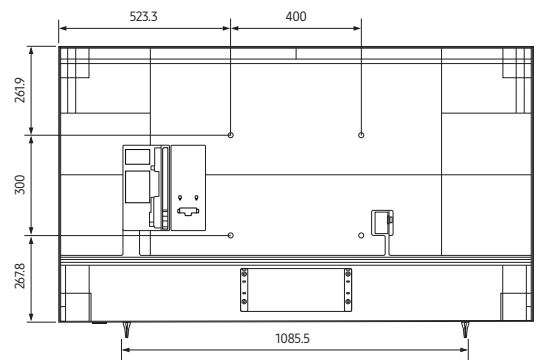
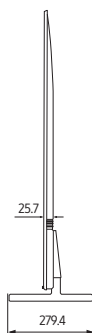
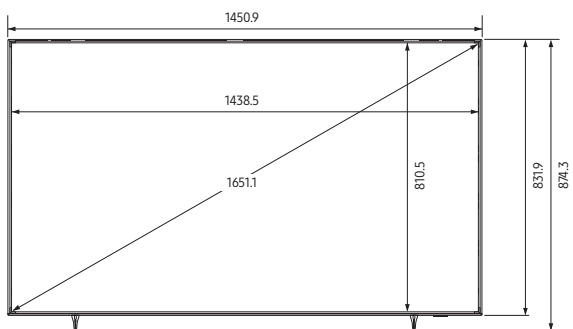

## Technical drawings

75"

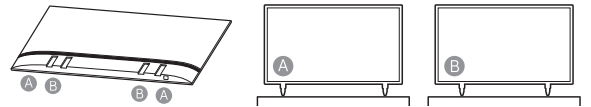
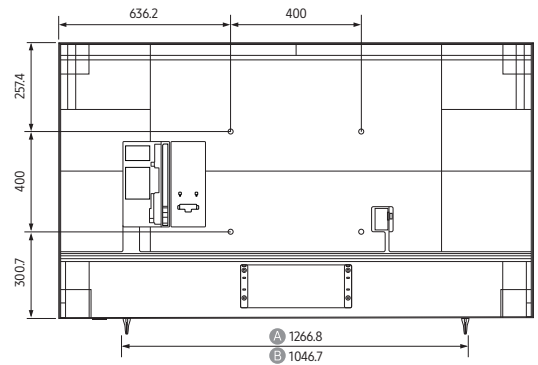
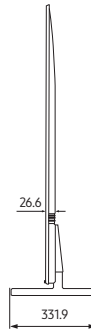
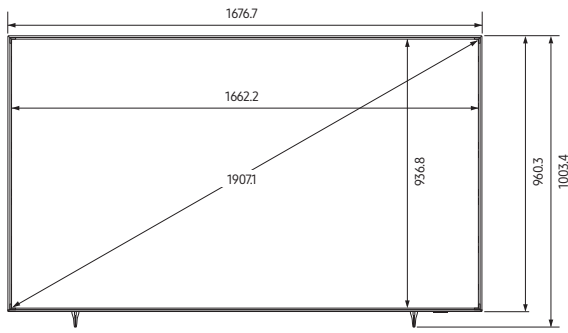

\* There are two options for the 75" stand.  
Customer can choose one of the two according to the situation.

## Connectors

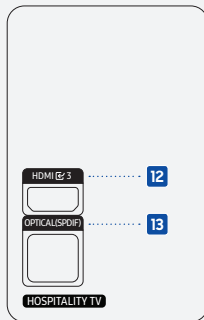
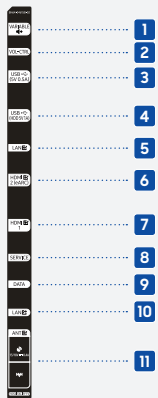

- |                         |                           |                           |
|-------------------------|---------------------------|---------------------------|
| <b>1</b> VARIABLE       | <b>6</b> HDMI IN 2 (eARC) | <b>11</b> ANT IN          |
| <b>2</b> VOL-CTRL       | <b>7</b> HDMI IN 1        | <b>12</b> HDMI IN 3       |
| <b>3</b> USB (5V 0.5A)  | <b>8</b> SERVICE          | <b>13</b> OPTICAL (SPDIF) |
| <b>4</b> USB (HDD 5V1A) | <b>9</b> DATA             |                           |
| <b>5</b> LAN IN         | <b>10</b> LAN OUT         |                           |

# AIR WAVE

For more information, get in touch: 01403 783 483 | [info@airwave.tv](mailto:info@airwave.tv)